

# Durlum Tubular Linear Ceiling

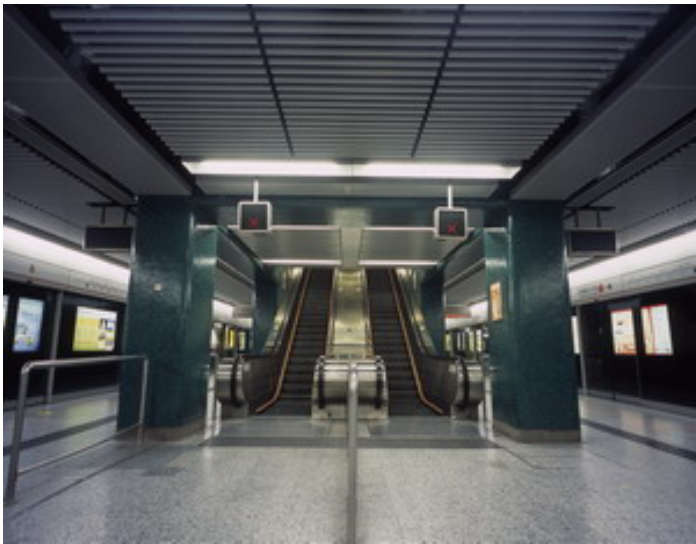

Durlum Tubular – Linear flow open concept tubular metal ceiling

## Durlum Tubular Linear Ceiling

Durlum Tubular is designed to be an open ceiling which provides linear flow of lines in its esthetic appearance. It consists of linear lamellas in 250mm vertical fins with a 50mm in diameter circular tubes attachments at its ends. The fins and tubular attachments are made out of extruded aluminium in powder coated finish.

The tubular fins are then attached to a carrier spaced at 1200mm c.c. powder coated to black colour as a standard. The spacing of these tubular fins are flexible up to the designers requirements, however the usual standard is 150,200,250 or 300mm spacing apart.

With its spacing in regular and different modules, the ceiling system is able to create patterns made out of different lengths which render this ceiling system being unique design ceiling.



Durlum Tubular can also be designed as a curve ceiling elements with its support curving in one direction, to create a curvature concave or convex flow line.



The curve in section tubular ceiling will create linear lines creating a directional flow.

# Durlum Tubular Linear Ceiling construction details

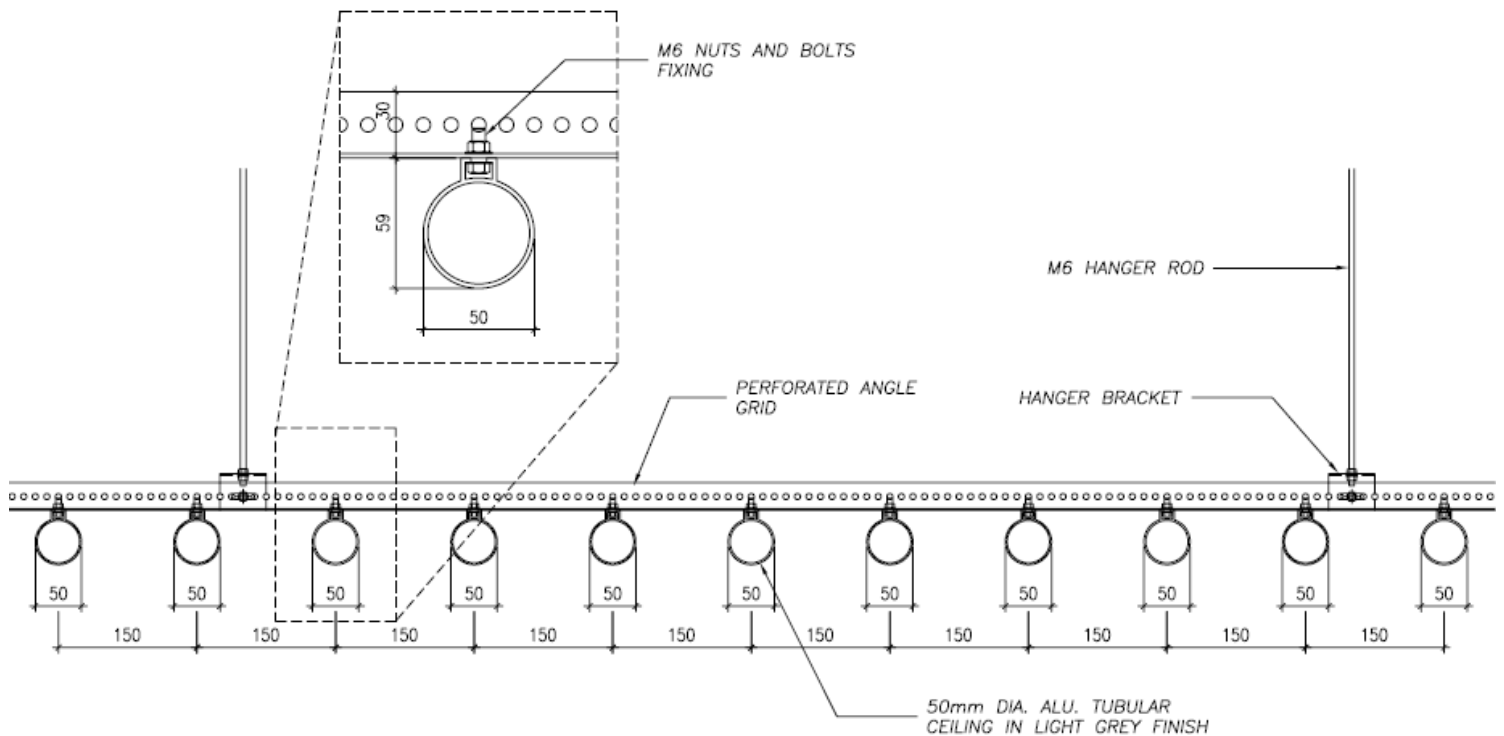
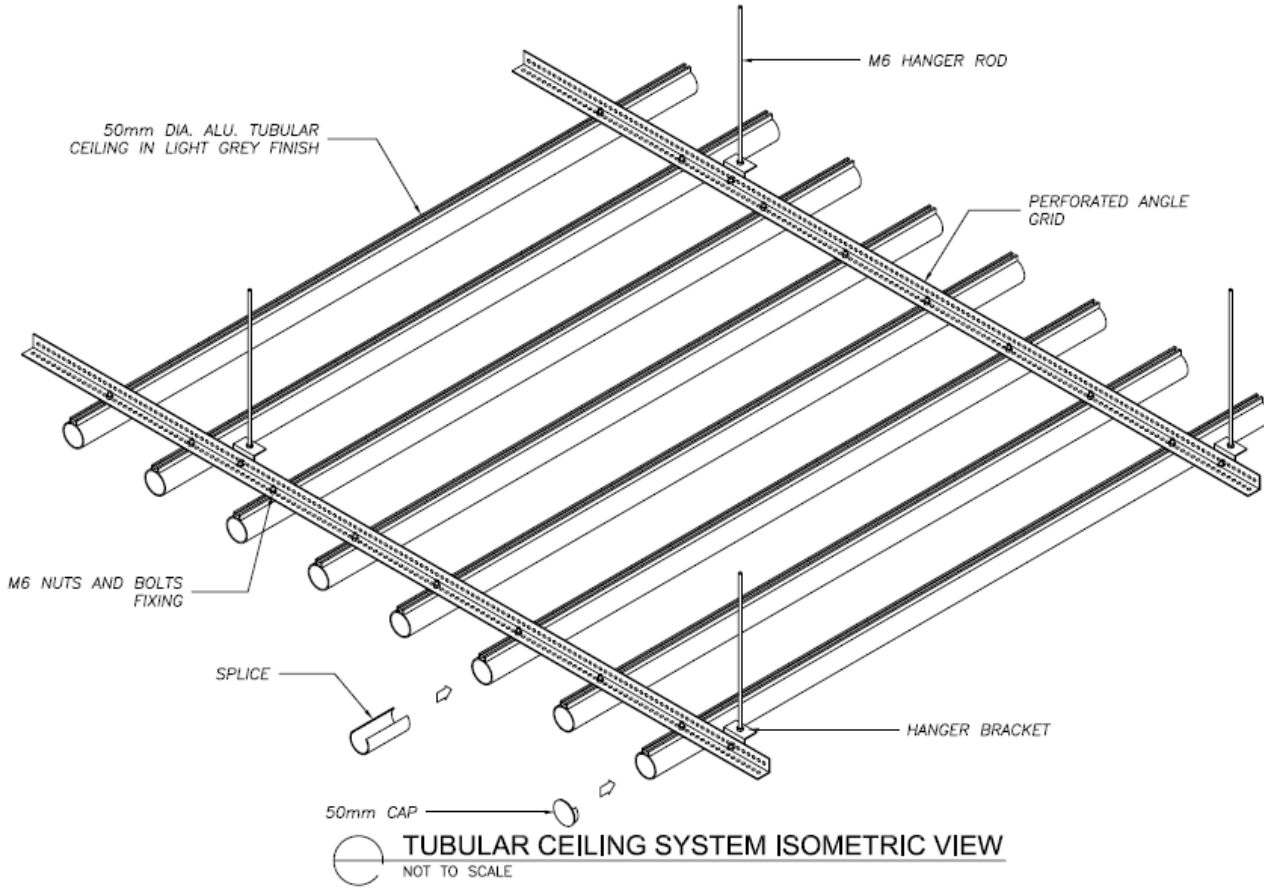



# Durlum T-Tubular Linear Ceiling construction details

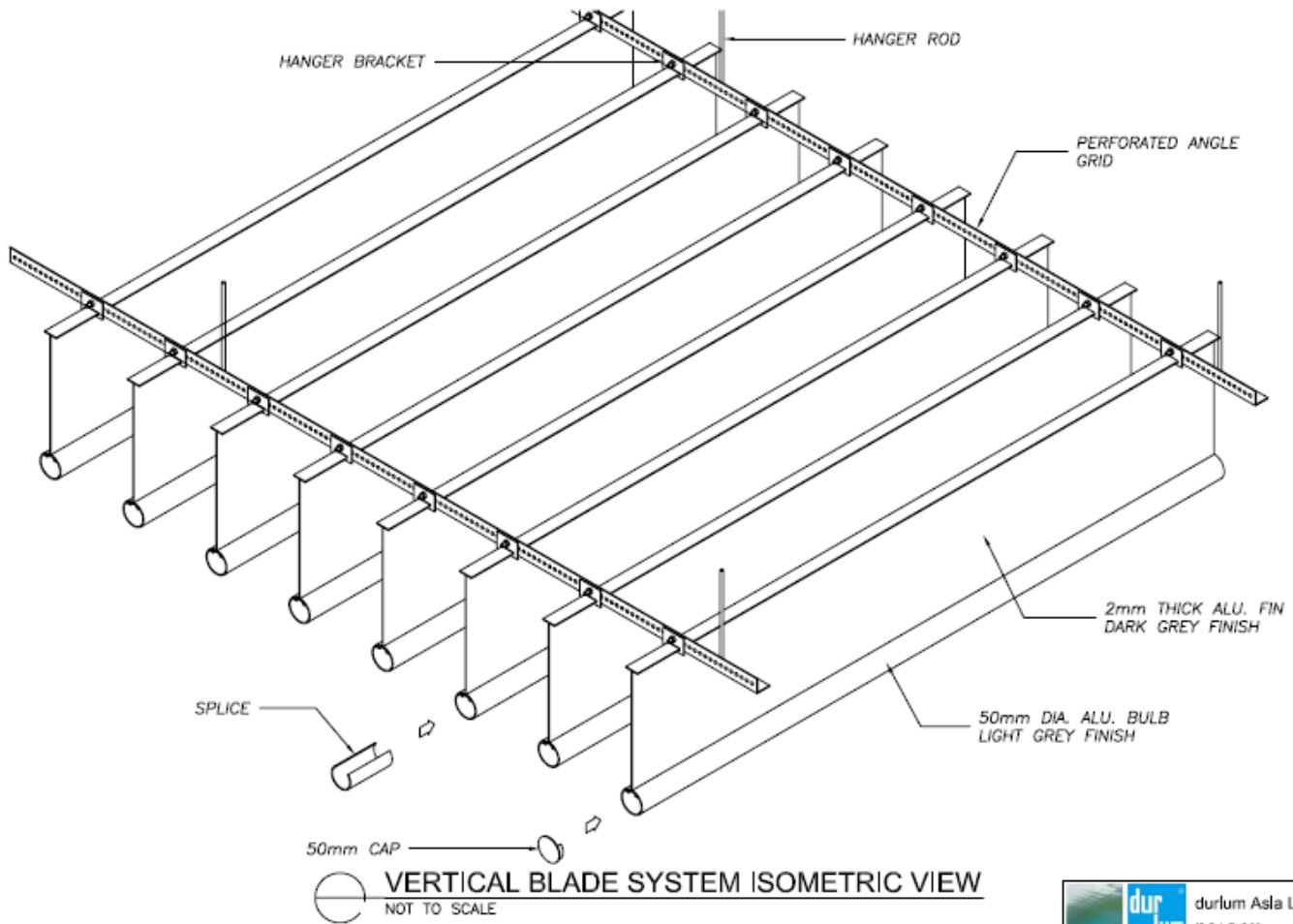

**durlum Asia Limited**  
 47, Peak 46 Building  
 13-23 Tai Wo Street, Mong Kok, Hong Kong  
 Tel: +852 2861 1111 Fax: +852 2863 1111  
 Website: www.durlum.com

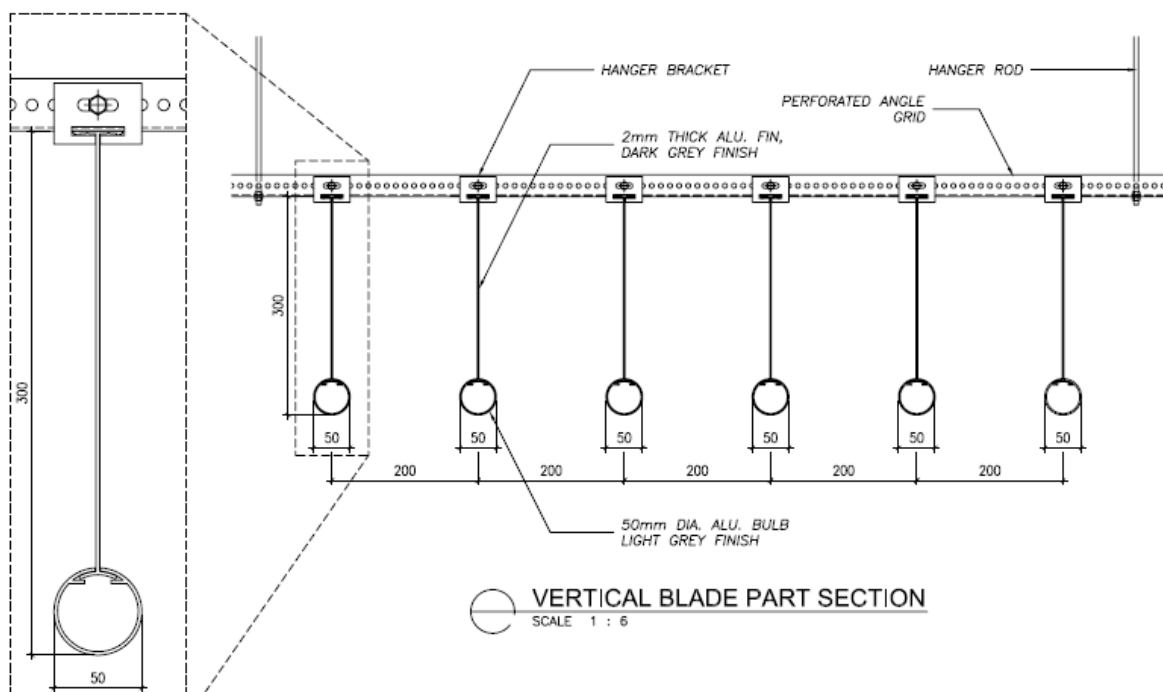

## Durlum Tubular Linear Ceiling Grid Fixing Accessories

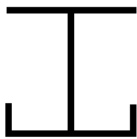

### U 1093

- Doppelhakenprofil  
DH 28

### U 1093

- Double hook-on profile  
DH 28

### U 1093

- *Porteur à crochet  
double DH 28*

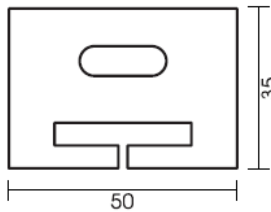

### U 1093-V

- Kreuzverbinder für  
Doppelhakenprofil /  
Rostwinkel U 1040

### U 1093-V

- Cross connector for  
double hook-on profile /  
L-shaped primary car-  
rier U 1040

### U 1093-V

- *Eclisse croisée pour  
porteur à crochet  
double / porteur  
primaire U 1040*

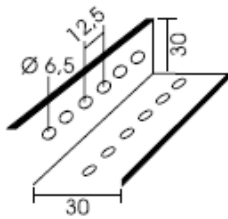

### U 1040

- Rostwinkel mit Regel-  
lochung  
• L=4000mm

### U 1040

- L-shaped primary  
carrier with regular  
perforation  
• L=4000mm

### U 1040

- *Porteur primaire perforé*  
• L=4000mm

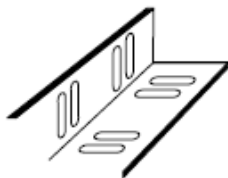

### U 1041

- Rostwinkelverbinder  
• L=150mm

### U 1041

- L-shaped primary  
carrier connector  
• L=150mm

### U 1041

- *Eclisse pour U 1040*  
• L=150mm

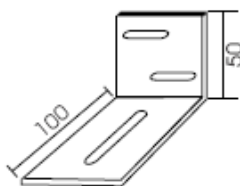

### U 1042

- Wandanker 2mm  
• Verzinkt

### U 1042

- Wall bracket 2mm  
• Galvanized

### U 1042

- *Raccord mural 2mm*  
• *Acier galv.*

## Durlum Tubular Linear Ceiling – Lighting Interface

As these tubular ceiling are linear in nature, several types of light fittings from Durlum range can be integrated as part of the lighting solution:



Sekundär-Reflektorleuchte aus Stahlblech, Zinkweiß thermolackiert. Reflektorhalschale aus mikroperforiertem Stahlblech, weiß thermolackiert, mit innenliegendem Lichtdiffuser. Für den Lampentausch muss die Lampenabdeckung nicht abgenommen werden. Auch als Lichtbandmontage möglich. Der Reflektor ist symmetrisch strahlend mit zusätzlicher Deckenaufhellung.

Secondary reflector luminaire in galvanized steel, white powder coated. Reflector trough made of micro perforated steel plate, white powder coated, with a diffuser inside. There is no need to remove the reflector for changing lamps. A continuous installation like batten luminaires is possible. The reflector creates a symmetrical light distribution with an additional illumination of the ceiling.

Luminaire à réflexion secondaire en acier galvanisé, peint en blanc. La rigole de réflexion est en tôle d'acier micro perforée, peignée en blanc avec diffuseur interne. Il n'est pas nécessaire de démonter le cache lampes pour changer les ampoules. Un montage continu type réglette est possible. Le réflecteur a un rayonnement symétrique avec une illumination supplémentaire du plafond.

## Alouette AL2 Pendant Lights

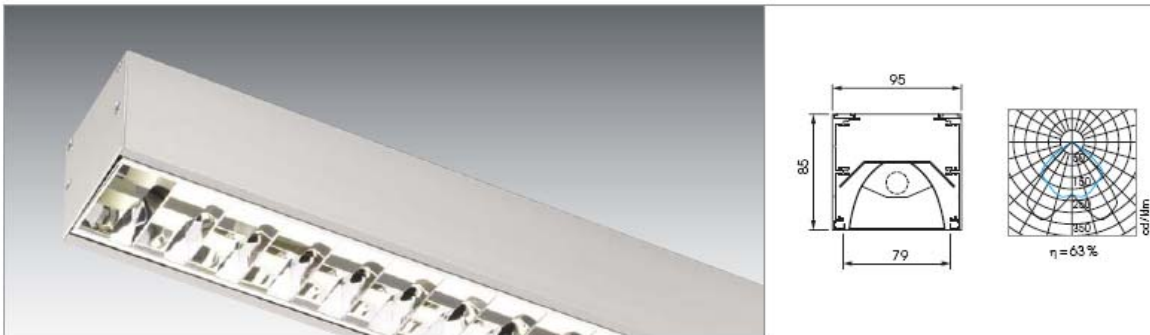

Anbau- und Pendelleuchte, Alu-Profil farblos eloxiert in 1-, 2- und 3-längiger Ausführung. Spiegelraster Aluminium hochglanz, rundum entblendet. Etwaige Stahlseilabhängung bitte separat bestellen.

Suspended and surface mounted luminaire, aluminium profile natural anodized, available in single-, dual- and triple-length. Mirror louvre, highly polished aluminium, glare free. Please order any relevant steel wire suspensions separately.

Luminaire apparent et suspendu, profilé en aluminium, anodisé nature, en version mono, duo et triple longueurs. Ecran en aluminium miroité poli brillant, non-éblouissant de toutes les directions. Veuillez s.v.p commander séparément des suspensions à câble d'acier.

## AK85 Pendant Lights

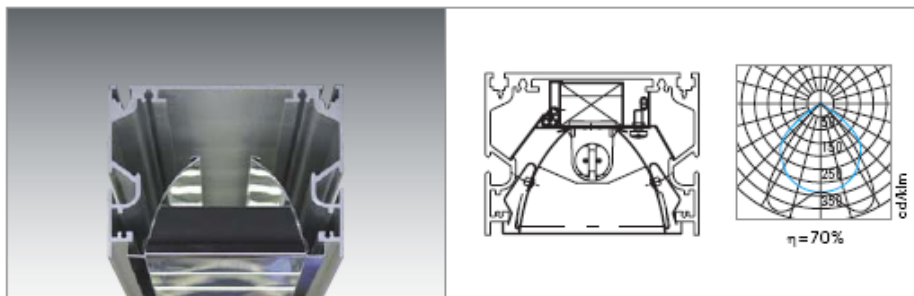

Leuchteneinsatz mit Parabolraster. [Art. No. siehe Seite 2.21]

Basic luminaire set with parabolic louvre. [Art. No. please see page 2.21]

Jeu d'éclairage de base avec grille parabolique. [Art. No. voir page 2.21 s.v.p.]

Omega 76 track lighting – Providing continuous linear lights.

